

PARKSIDE TIMBER

Product Catalogue v1.0

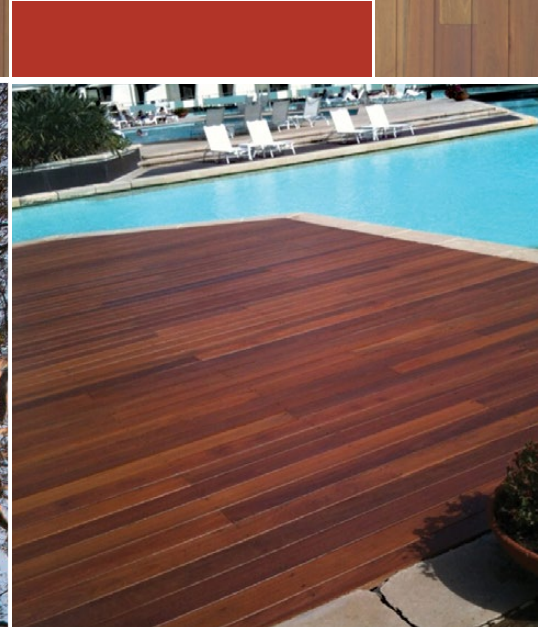

Introduction

Product Catalogue v1.0

INTRODUCTION

REFERENCES	2
DEFINITIONS	2
BUSHFIRE RESISTANCE	2
SUSTAINABILITY of PRODUCT	2

FLOORING

SPECIES	3
TOLERANCES & FINISH	3
SIZE & PROFILES	3
LENGTH & GRADES	4
MOISTURE CONTENT	4
PACK SIZE, DETAILS, PRODUCT DATA	4
APPENDIX A - PERMISSIBLE FEATURES	5

DECKING

SPECIES	7
TOLERANCES	7
SIZE & PROFILES	7
LENGTH & GRADES	8
MOISTURE CONTENT	8
TREATMENT	8
PACK SIZE, DETAILS, PRODUCT DATA	8
PERMISSIBLE FEATURES	9

CLADDING

SPECIES	11
TOLERANCES & FINISH	11
PROFILES	11
LENGTH & GRADES	12
MOISTURE CONTENT	12
BOW & SPRING	12
TREATMENT	12
PACK SIZE, DETAILS, PRODUCT DATA	12

STRUCTURAL & JOINERY

SPECIES	13
TOLERANCES & FINISH	13
SIZE & LENGTH	13
MOISTURE CONTENT	13
TREATMENT	13
PACKAGE DETAILS	13
CONFORMANCE	14
BOW, SPRING & TWIST ALL GRADES	14
VISUAL STRESS GRADING	15





SCOPE

Production, Packaging and Technical Aspects of PARKSIDE HARDWOOD Products.

REFERENCES

A.S. 2796.1 - 1999 Timber - Hardwood - Sawn and milled products - Product specification

A.S. 2796.2 - 2006 Timber - Hardwood - Sawn and milled products - Grade description

A.S. 2082 - Visually Graded Hardwood for Structural Purposes.

Chain of Custody Certificate for Parkside Timber complying with AS 4707:2006 from EWPA as per PEFC and AFS requirements.

DEFINITIONS

ACQ

An abbreviation for Alkaline, Copper and Quaternary. The treatment chemical used on our sapwood.

Chip Marks

Impressions in dressed timber surface, usually caused by chips of wood lodged between the cutters or other machine parts and the surface.

Conformity

Fulfilment by a product, process or service of specified requirements.

Glazed Surface

A surface burnished by friction.

Pause Marks (Machine Burn)

Traverse depressions or burnt or burnished bands on a dressed surface caused by friction during a pause in the feeding.

Roller Marks

Regular indentations on a machined surface caused by the feed rollers.

Skip (Hit and Miss)

Areas of the surface that were missed during dressing.

Torn Grain

Where fibre bundles or pieces of wood have been partly or fully torn out from the surface by a cutting tool.

BUSHFIRE RESISTANCE

All Spotted Gum and Red Ironbark specie products are bushfire resistant to BAL 12.5, 19, and 29 as per AS3959 for required applications. If you require your order to meet these BAL requirements, please specify this on your order.

SUSTAINABILITY OF PRODUCT

All PARKSIDE hardwood products are sourced and certified from sustainably managed sources. PARKSIDE has Chain of Custody certification through the PEFC scheme by AFS. This third party accreditation supports sustainable forestry management and promotes continuous improvement in systems and processes.



PLEASE NOTE

Colour variations within timber species in normal photography are only indicative of the colour range. PARKSIDETIMBER retains the right to vary specifications without notice due to our policy of continued development in our product range.

Whilst every effort has been made to ensure the accuracy of this information to assist in projects using PARKSIDE TIMBER. At times we recommend trade people, however we cannot accept liability for their workmanship. Parkside Timber is a supplied of quality hardwood products only.

Information is subject to change without notice. Product Catalogue v1 MAY 2014.

Flooring

Product Catalogue v1.0

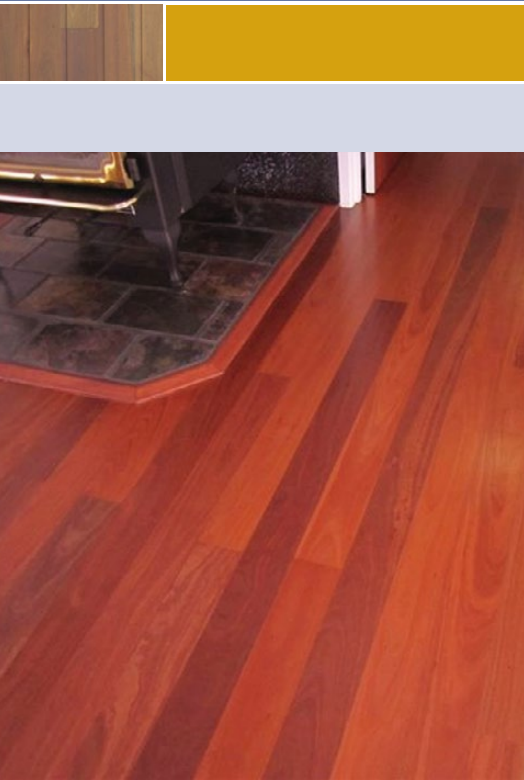

SPECIFICATION

SPECIES

PARKSIDE FLOORING species available are:

SPOTTED GUM

Spotted Gum is a beautiful Queensland specie timber, botanically named *Corymbia Citriodora*, and is a unique blend of brown and grey colours.

FOREST REDS

Forest Reds is a blend of red coloured Queensland Eucalypts, predominately, Forest Red Gum; Red Ironbark and Grey Gum.

IRON BARK

Ironbark is Queensland Grey and Red Ironbark.

MIXED BLEND

Mixed Hardwood is a mixed blend of Queensland based lighter coloured species.

Other species may be available on request.

1. Copies of this Data sheet are available from Parkside Timber Corporate Office.

TOLERANCES

At the time of milling, the tolerances on any dimension in the thickness and width of the piece will be as follows:

Overall thickness: $\pm 0.5\text{mm}$ provided:

- a) Mismatch does not exceed 0.5 mm; or
- b) T & G clearance is not more than 0.6 mm nor less than 0.3 mm.
- c) See Appendix A for other tolerances and permissible features

FINISH

Refer to Appendix A: Parkside Naturawood Flooring Permissible Limits.

PROFILES AND SIZES

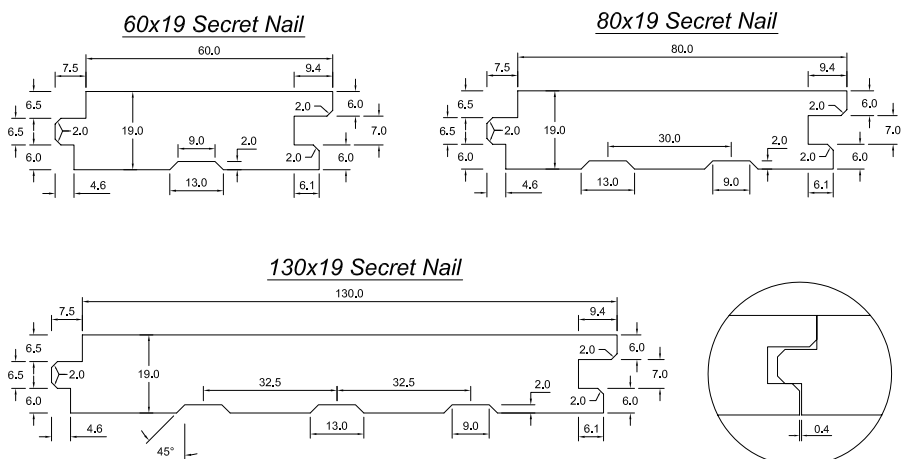

SCOPE

Parkside Flooring (Hardwood Flooring) - tongue and grooved and end matched, handed and installed in accordance with AS2796.1-1999 and AS2796.2-2006

APPLICATION

This specification sets out the product and packaging requirements for Parkside Flooring.

Parts of A.S. 2796 have been used in formulating this specification. However, as the commercial grades used in the market place differ from A.S. 2796, not all grades of this product comply with this Australian Standard.

Where any conflict occurs between this specification and any referenced document, this specification shall take precedence.

LENGTHS

Random lengths are normally supplied, however set lengths may be available upon request.

The following specifications apply to Parkside Flooring:

- Minimum: Flooring - 0.9 m
- Maximum: Flooring - 5.9 m

GRADES

Visually graded to A.S. 2796 to the grades below:

SPECIE	FEATURE	STANDARD	SELECT
Mixed Species	Yes	Yes	Yes
Spotted Gum	Yes	Yes	Yes
Grey Ironbark	-	Yes	Yes
Forest Reds	-	Yes	Yes

MOISTURE CONTENT

At the time of machining 9 to 14%. As per A.S. 2796.1 -1999.

TREATMENT

All sapwood is ACQ treated to H3.

PACKAGE DETAILS

Each hardwood flooring pack supplied by Parkside Timber has a number of package guidelines, to help ensure consistent quality and presentation of the product.

There are typically six plastic straps on a pack, which are assisted by a wooden glut at the base of the pack (70/90 x 45mm) and at the top of a pack a wooden packer, assisting in prevention of marking on the finished product. Each pack comes fully wrapped in plastic, to help protect from potential irritants.

PLEASE NOTE – plastic wrap is not suitable as a comprehensive protective barrier from the elements. The plastic wrap is designed to give limited protection during transport and handling only.

PACK SIZES

Pack size by Lineal Metre approx.

END SECTION	ROW QUANTITY	HEIGHT QUANTITY	PACK SIZE
60 x 19	8	15	620
80 x 19	6	15	470
130 x 19	4	15	320

PRODUCT DATA

ACTUAL SIZE	NOMINAL SIZE	DENSITY (KG/M ³)	WEIGHT PER PACK (KG)
60 x 19	75 x 25	587	930
80 x 19	100 x 25	608	940
130 x 19	150 x 25	657	962

LAYING INSTRUCTIONS

Please refer to Parkside document – Flooring Laying instructions for further details on laying instructions and expectations.

PACK TAG

PARKSIDE TIMBER	
Prod: 080019 FLOORING SPOTT	Grade: Standard
Spec: Spotted Gum	Len: 4501.0
Size: 80 x 19	
300038774	
<small>WARNING: This timber has been used and must be used in dry areas. The plastic wrapping is designed to give limited protection during transport and handling only. For more information on handling, storage and use of this timber, refer to our literature. Please refer to our website for more information on handling, storage and use of this timber. If a copy is not with this pack, please contact your supplier of Parkside Timber.</small>	
300038774	300038774
Product: 080019 FLOORING SPOTTED GU Volume: 450.00	Product: 080019 FLOORING SPOTTED GU Volume: 450.00

Flooring

Product Catalogue v1.0 - Appendix A

PERMISSIBLE FEATURES IN ALL GRADES

BOW, SPRING and TWIST

See Tables

CUPPING

<= 1mm per 100mm Width

BURLS, BORER MARKS

No Limitation

HOB NAILS, BIRDSEYE

No Limitation

NOT PERMITTED in ANY GRADE on SURFACE

- Enclosed termite galleries;
- Heart and Heart shakes
- Shakes; Cross-fractures and cross-shakes
- Splits and End splits
- Decay and primary rot
- Lyctid-susceptible sapwood
- Loose Gum Veins
- Gum Pockets
- Overgrowth of Injury
- Other pockets from surface to surface or intersecting an end
- Holes and knot holes > 10 mm.

NOT PERMITTED in ANY GRADE on ANY EXPOSED SURFACE

- Want and Wane; Mechanical damage
- Stain other than natural discolouration
- Sticker marks.

PERMISSIBLE FEATURES

PERMISSIBLE FEATURES	SELECT GRADE	STANDARD GRADE	FEATURE GRADE
SAPWOOD	No limitation if Non-susceptible or treated	No limitation if Non-susceptible or treated	No limitation if Non-susceptible or treated
TIGHT KNOTS and associated voids	<=15 mm or 1/4W, <= 1 / any 1M	<=40 mm or 1/3W, <=2 / any 1M	<=50 mm or 3/8W, <=4 / any 1M
HOLES < 1 mm in DIAMETER	Concentration < 20 in any 100 cm ² Spread < Average of 15 per 100 cm ² over the length of the board	Concentration < 40 in any 100 cm ² Spread < Average of 30 per 100 cm ² over the length of the board	No limitation
HOLES > 1 mm in DIAMETER	< 2 mm in diameter Concentration < 6 in any 100 cm ² Spread < Average of 4 per 100 cm ² over the length of the board	< 3 mm in diameter Concentration < 20 in any 100 cm ² Spread < Average of 4 per 100 cm ² over the length of the board	< 3 mm in diameter – no limitation >3 mm in diameter and < 10 mm in diameter no more than 3 in any 1m length
TIGHT GUM VEINS (Quartersawn, straight line)	<=2 mm wide, individual length. <=250 mm, Aggr. <=1/2L	<=5 mm wide Aggr. <=1/2L	Unlimited
TIGHT GUM VEINS (Backsawn, blotch)	<=2 mm wide, individual length. <=250 mm, Aggr. <=1/2L	2 mm deep < 1000mm long Aggregate < 2/3 of length < 3/4 of face width	Unlimited
LOOSE GUM VEINS	Not Permitted	<=3 mm wide, Aggregate. <=1/6 L	<=3 mm wide, Aggregate. <=1/4 L
GUM POCKETS, OVERGROWTH of INJURY, OTHER POCKETS	Not Permitted	<=500 mm ² <=3 mm deep	<=1200 mm ² <=3 mm deep
KNOT CHECKS	Not Permitted	<=2 mm wide	Unlimited but structurally sound
CHECKS	<=0.5 mm wide, Aggr. <=1/2 of length	<=2 mm wide, ind. <=250 mm	< 3 mm wide Unlimited length
STAINS, natural discolouration	Slight up to 10% of board surface area	No Limitation	No Limitation
BLACK SPECK	Slight up to 10% of board surface area	No Limitation	No Limitation
STICKER MARKS	Not Permitted	Not Permitted	No Limitation



TOLERANCES - ALL GRADES

Overall thickness	+ or - 0.5 mm
Other dimensions in thickness	+ or - 0.3 mm
Mismatch	≤0.5 mm
Clearance tongue and groove	≤0.6 mm and ≥ 0.3 mm
Dimensions in width, including cover width	+ or - 0.3 mm

MACHINING IMPERFECTIONS and SURFACE FINISH

Skip, hit and miss	Once per board, ≤0.5 mm deep
Cutter marks	>10/30mm
Raised grain, ridges, torn grain	≤0.5 mm
Chip marks or roller marks	Continuous 1/3 of L unaffected, (≤0.5 mm deep)
Pause marks or glazed surfaces	Once per board and unlimited in feature
Knot chipping	≤3 mm wide
Torn corners and edges, gouge, kick out	Not permitted

TONGUE and GROOVE IMPERFECTIONS

Short Tongue, Broken Tongue, Broken Under-Groove All Grades

< 50% of tongue or under-groove missing	Individual ≤ 250 mm Aggregate ≤ 500 mm or ¼ of L (lesser of)
> 50% of tongue or under-groove missing	Individual ≤ 200 mm Aggregate ≤ 250 mm or ¼ of L (lesser of)

ON CONCEALED SURFACES - ALL GRADES

Natural features	As for Natural Grade (High Feature Grade)
Want and Wane, Mechanical damage	1/3 of W or T; aggregate. ≤300 mm
Stains and Stickermarks	Unlimited
Heart Checks	Feature Grade only unlimited

BOW, SPRING and TWIST - ALL GRADES

Length in Metres	BOW		SPRING			TWIST			Length in Metres
	THICKNESS		WIDTH			WIDTH			
	15 mm	19 mm	60 mm	80 mm	130 mm	60 mm	80 mm	130 mm	
1.2	6	5	6	5	4	2	3	5	1.2
1.8	13	11	14	12	8	4	5	8	1.8
2.4	22	19	25	21	15	5	6	10	2.4
3.0	35	30	40	33	23	6	8	13	3.0
3.6	50	45	60	50	33	7	10	16	3.6
4.2	70	60	80	67	48	8	11	18	4.2
4.8	90	75	100	83	58	10	13	21	4.8
5.4	110	95	130	106	73	11	14	23	5.4
6.0	130	110	150	130	90	12	16	26	6.0

PARKSIDE

Decking

Product Catalogue v1.0



SCOPE

Production and Packaging of Parkside Decking.

APPLICATION

Product supplied to this specification will comply with A.S 2796.1 and A.S. 2796.2 as well as meeting the additional requirements of this specification.

Where any conflict occurs between this specification and any referenced document, this specification takes precedence.

SPECIFICATION

SPECIES

PARKSIDE DECKING species available are:

SPOTTED GUM

Spotted Gum is a beautiful Queensland specie timber, botanically named *Corymbia Citriodora*, and is a unique blend of brown and grey colours.

FOREST REDS

Forest Reds is a blend of red coloured Queensland Eucalypts, predominately, Forest Red Gum; Red Ironbark and Grey Gum.

IRON BARK

Ironbark is Queensland Grey and Red Ironbark.

MIXED BLEND

Mixed Hardwood is a mixed blend of Queensland based lighter coloured species.

Other species may be available on request.

1. Copies of this Data sheet are available from PARKSIDETIMBER Corporate Office.

TOLERANCES

As per table in Appendix A on page 6.

PROFILES AND SIZES

Machined on 4 surfaces with a 3mm radial arris.

Both ends trimmed square.

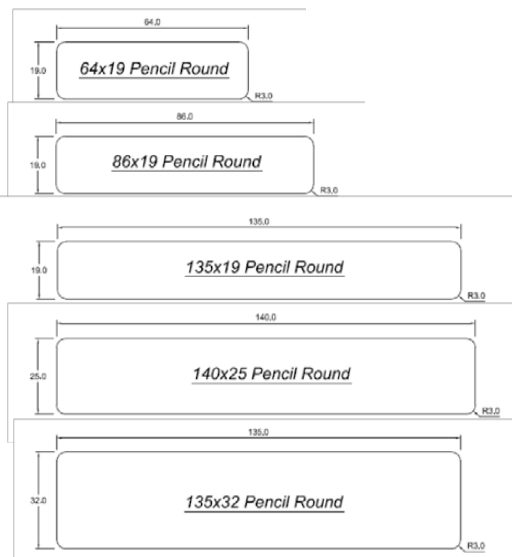

64 x 19 | 86 x 19 | 135 x 19 | 135 x 32 | 140 x 25

Specialised Commercial Decking Profiles are available to suit specific applications and specifications upon request.

Architectural screening available in 64 x 19 | 86 x 19 | 135 x 19



LENGTHS

For all sizes and packs (unless otherwise ordered):

- Minimum length - 1.5m
- Maximum length - 5.9m

GRADES

Visually graded to A.S. 2796 to the grades below:

SPECIE	FEATURE	STANDARD	SELECT
Mixed Species	Yes	Yes	Yes
Spotted Gum	Yes	Yes	Yes
Grey Ironbark	-	Yes	Yes
Forest Reds	-	Yes	Yes

MOISTURE CONTENT

At the time of delivery, the moisture content anywhere within any piece shall not be less than 10% nor more than 18%.

TREATMENT

All sapwood is ACQ treated to H3.

PACKAGE DETAILS

Each hardwood decking pack supplied by PARKSIDE TIMBER has a number of package guidelines, to help ensure consistent quality and presentation of the product.

There are typically six plastic straps on a pack, which are assisted by a wooden glut at the base of the pack (70/90 x 45mm) and at the top of a pack a wooden packer, assisting in prevention of marking on the finished product. Each pack comes fully wrapped in plastic, to help protect from potential irritants.

PLEASE NOTE – plastic wrap is not suitable as a comprehensive protective barrier from the elements. The plastic wrap is designed to give limited protection during transport and handling only.

PACK SIZES

Pack size by Lineal Metre approx.

END SECTION	ROW QUANTITY	HEIGHT QUANTITY	PACK SIZE
65 x 19	8	15	620
86 x 19	6	15	470
135 x 19	4	15	320

PRODUCT DATA

ACTUAL SIZE	NOMINAL SIZE	DENSITY (Kg/m ³)	WEIGHT per PACK (Kg)
65 x 19	75 x 25	587	930
86 x 19	100 x 25	608	940
135 x 19	150 x 25	657	962
135 x 32	150 x 38	1000	1197
140 x 25	150 x 32	1000	1200

PACK TAG

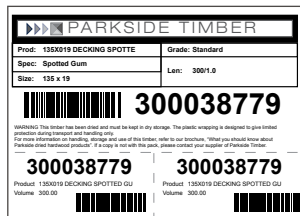

PARKSIDE

Decking

Product Catalogue v1.0

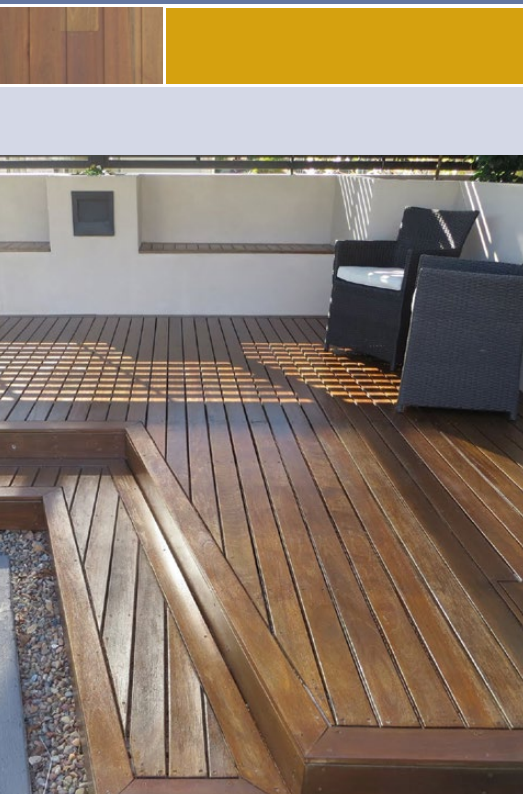

GRADING DECKING

PERMISSIBLE FEATURES - ALL GRADES

SLOPING GRAIN	40 in 300
CUPPING	≤ 1 mm per 100 mm W
BURLS, BIRDSEYE	No Limitation
HOB NAILS, BORER MARKS	No Limitation
BLACK SPECK	No Limitation
SAPWOOD	Unlimited if non-susceptible or treated
STAINS, SAPWOOD natural colour variation	No Limitation

MACHINING IMPERFECTIONS and SURFACE FINISH - ALL GRADES

Skip, hit and miss	Once/board, ≤ 0.5 mm deep
Cutter marks	>10/30mm
Raised grain, ridges, torn grain	≤ 0.5 mm
Chip marks or roller marks	Continuous 1/3 of L unaffected
Pause marks or glazed surfaces	Once per board
Knot chipping	≤ 3 mm wide
Torn corners and edges, gouge, kick out	Permitted within the last 100mm each end

TOLERANCES - ALL GRADES

All Dimensions ± 0.5mm in W and T

BOW, SPRING and TWIST - ALL GRADES

Length in Metres	BOW	SPRING		TWIST		Length in Metres
		WIDTH		WIDTH		
	19 mm	64 mm	86 mm	64 mm	86 mm	
1.5	8	8	6	3	4	1.5
1.8	11	11	8	4	5	1.8
2.4	19	19	15	5	6	2.4
3.0	30	30	23	6	8	3.0
3.6	45	45	35	7	10	3.6
4.2	60	60	47	8	11	4.2
4.8	75	75	58	10	13	4.8
5.4	95	95	75	11	14	5.4
6.0	110	115	95	12	16	6.0



PERMISSIBLE FEATURES

PERMISSIBLE FEATURES	SELECT GRADE	STANDARD GRADE	HIGH FEATURE
TIGHT KNOTS and associated voids	≤ 15 mm, ≤ 1 / any 1M	≤ 40 mm, ≤ 1 / any 1M	≤ 50 mm, ≤ 1 / any 1M
HOLES including unstained insect holes measure diameter	≤ 2 mm dia, < 2x15 mm, 6 per 80 x 120mm or ≤ 12 / any 1M	≤ 3 mm dia, < 3x40 mm, 20 per 80 x 120mm or ≤ 20 / any 1M	≤ 3 mm dia, No limitation
INSECT HOLES stained (Ambrosia) measure diameter	≤ 1 mm dia, < 1x15 mm, 4 per 80 x 120mm or ≤ 10 / any 1M	≤ 2 mm dia, < 2x40 mm, 12 per 80 x 120mm or ≤ 20 / any 1M	3 to ≤ 10 mm; ≤ 3 per any 1 M
TIGHT GUM VEINS	≤ 2 mm wide, ≤ 250 mm	≤ 5 mm wide	No Limitation
BACKSAWN GUM VEINS	Not Permitted	≤ 60 mm wide, ≤ 2 mm deep, ≤ 1/any 1 M	No Limitation
LOOSE GUM VEINS	Not Permitted	≤ 3 mm wide, no end, aggr. ≤ L/6 length	≤ 3 mm wide, no end, aggr. ≤ L/4 length
GUM POCKETS, OVERGROWTH of INJURY, OTHER POCKETS	Not Permitted	≤ 500 mm ² , (20 x 25mm) ≤ 3 mm deep	≤ 1200 mm ² , (15 x 75mm) ≤ 3 mm deep
KNOT CHECKS	≤ 1 mm wide	≤ 2 mm wide	≤ 3 mm wide
CHECKS	≤ 1 mm wide, ind. ≤ 250 mm	≤ 2 mm wide, ind. ≤ 250 mm	≤ 3 mm wide
STICKER MARKS	Not Permitted	Not Permitted	Not Permitted

NOT PERMITTED IN ANY GRADE ON ANY SURFACE:

- Enclosed termite galleries
- Heart and Heart shakes
- Shakes
- Cross-fractures and cross-shakes
- Splits and End splits
- Decay and primary rot
- Loose Gum Veins
- Gum Pockets
- Overgrowth of Injury
- Other Pockets from surface to surface or intersecting an end

NOT PERMITTED IN ANY GRADE ON ANY EXPOSED SURFACE:

- Want and Wane
- Mechanical damage
- Stain other than natural discolouration

PARKSIDE

Cladding

Product Catalogue v1.0



SPECIFICATION

SPECIES

PARKSIDE CLADDING species available are:

SPOTTED GUM

Spotted Gum is a beautiful Queensland specie timber, botanically named *Corymbia Citriodora*, and is a unique blend of brown and grey colours.

FOREST REDS

Forest Reds is a blend of red coloured Queensland Eucalypts, predominately, Forest Red Gum; Red Ironbark and Grey Gum.

IRON BARK

Ironbark is Queensland Grey and Red Ironbark.

MIXED BLEND

Mixed Hardwood is a mixed blend of Queensland based lighter coloured species.

Other species may be available on request.

1. Copies of this Data sheet are available from PARKSIDE TIMBER Corporate Office.

TOLERANCES

At the time of milling, the tolerance on any dimension shall be + or - 0.5mm, provided that any mismatch does not exceed 1.0mm

FINISH

Refer to Appendix A: Parkside Naturawood Flooring Permissible Limits.

PROFILES

75x19 Shiplap

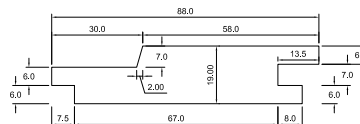

125x19 Shiplap

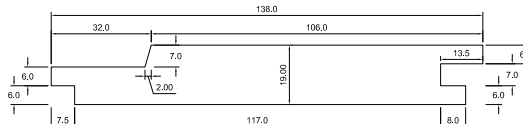

122x19 Chamfer

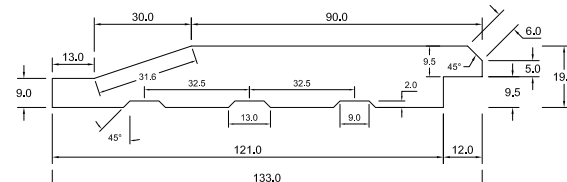

SCOPE

Production and packaging of PARKSIDE CLADDING.

APPLICATION

Product supplied to this specification will comply with A.S 2796 as well as meeting the additional requirements of this specification, except where any conflict occurs between this specification and any referenced document, this specification shall take precedence.

The most relevant (but not all) sections of A.S 2796 are reproduced in appendices to this specification.



LENGTHS

For all sizes:

- Minimum length - 1.5m
- Maximum length - 5.9m

All packs come as random lengths within the above ranges

GRADES

Visually graded to A.S. 2796 to the grades in the table below.

SPECIE	FEATURE	STANDARD	SELECT
Mixed Species	Yes	Yes	Yes
Spotted Gum	Yes	Yes	Yes
Grey Ironbark	-	Yes	Yes
Forest Reds	-	Yes	Yes

MOISTURE CONTENT

At the time of delivery, the moisture content anywhere within any piece shall not be less than 10% nor more than 18% as per A.S. 2796. Shiplap 9 - 14% and Chamfer 10 -18%.

BOW and SPRING

Limits to bow and spring (in mm) are set out on page 9 of this catalogue.

TREATMENT

All sapwood is ACQ treated to H3.

PACKAGE DETAILS

Each hardwood cladding pack supplied by PARKSIDE TIMBER has a number of package guidelines, to help ensure consistent quality and presentation of the product.

There are typically plastic straps on a pack, which are assisted by a wooden glut at the base of the pack (70/90 x 45mm) and at the top of a pack a wooden packer, assisting in prevention of marking on the finished product. Each pack comes fully wrapped in plastic, to help protect from potential irritants.

PLEASE NOTE - plastic wrap is not suitable as a comprehensive protective barrier from the elements. The plastic wrap is designed to give limited protection during transport and handling only.

PACK SIZES

Pack size by Lineal Metre approx.

END SECTION	ROW QUANTITY	HEIGHT QUANTITY	PACK SIZE
75 x 19 Shiplap	6	15	460
125 x 19 Shiplap	4	15	320
122 x 19 Chamfer	4	15	320

PACK TAG

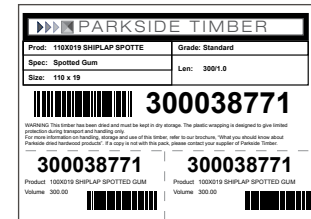

PRODUCT DATA

ACTUAL SIZE	NOMINAL SIZE	DENSITY (Kg/m ³)	WEIGHT per PACK (Kg)
75 x 19 Shiplap	100 x 25	608	940
125 x 19 Shiplap	150 x 25	657	962
122 x 19 Chamfer	150 x 25	657	962

PARKSIDE

F27 Structural & Joinery

Product Catalogue v1.0



SCOPE

Product and packaging specification for dry structural hardwood products, including joists and lintels.

APPLICATION

This specification sets out the product and packaging requirements of seasoned structural hardwood.

Product supplied to this specification complies with A.S. 2082 Visually Stress-Graded Hardwood as well as meeting the additional requirements of this specification.

Where any conflict occurs between this specification and any referenced document, this specification shall take precedence.

SPECIFICATION

SPECIES

PARKSIDE STRUCTURAL and JOINERY species available are:

SPOTTED GUM

Spotted Gum is a beautiful Queensland specie timber, botanically named *Corymbia Citriodora*, and is a unique blend of brown and grey colours.

IRON BARK

Ironbark is Queensland Grey and Red Ironbark.

1. Copies of this Data sheet are available from Parkside Timber Corporate Office.

GRADING

All PARKSIDE STRUCTURAL and JOINERY products are graded to F27 structural grading.

FINISH AND TOLERANCES

Dressed 4 sides with 5mm radius on each corner.

Tolerance: -0 +2 mm

SIZES

As shown in the table on page 12.

LENGTHS

0.9 m to 6.0m in 0.3 m increments.

MOISTURE CONTENT

Seasoned to 10% - 18% at time of delivery.

TREATMENT

All sapwood is ACQ treated to H3.

BRANDING

Each piece shall be branded with an ink type brand with the following information:

- AHQC logo
- F. Rating
- AHQC mill registration number

PACKAGE DETAILS

Job lots are packaged according to quantities ordered. However in general packaging shall comply with the requirements for stock packs as detailed below.

Lengths up to 3.6 m - 2 straps.

Lengths 3.9 to 4.8 m - 3 straps

Lengths over 4.8 m - 1 strap every 1.8 m

Smaller stock packs which result from the end of production runs are available from time to time.



PACKS ARE OF ONE SIZE AND LENGTH.

Each pack supplied by PARKSIDE TIMBER has a number of package guidelines, to help ensure consistent quality and presentation of the product. Each pack comes fully wrapped in plastic, to help protect from potential irritants. Please note – plastic wrap is not suitable as a comprehensive protective barrier from the elements. The plastic wrap is designed to give limited protection during transport and handling only.

PACK SIZES

35mm packs are 10 pieces high, while 45mm are 8 pieces, the below table shows the number of pieces each pack is wide.

	70	90	120	140	170	190	220	240
35mm	7	6	4	4	3	3	3	2
45mm	7	6	4	4	3	3	3	2

CONFORMANCE

Product supplied to this specification which meets the compliance requirements as set out in shall be deemed as meeting the requirements of this specification:

PRODUCT DATA

Weights of packs depend on moisture content and species.

SPECIES	DENSITY (Kg/m ³)	STRENGTH GROUP	JOINT GROUP	TOUGHNESS	SHRINKAGE (%) TANGENTIAL	DURABILITY CLASS ABOVE GROUND
Spotted Gum	1100	SD2	JD1	High	6.1	1
Red Ironbark	1100	SD3	JD1	Medium	6.3	1
Grey Ironbark	1100	SD1	JD1	High	7.5	1

TOLERANCES

- Sizes 2 & + 1 mm
- Squareness ± 20
- Square Docked both ends

BOW, SPRING AND TWIST - ALL GRADES

Length in metres	BOW		SPRING				Length in metres	Twist in mm	TWIST		
	THICKNESS		WIDTH						WIDTH		
	35 mm	45 mm	90 mm	120 mm	140 mm	190mm			90 mm	120/140 mm	190mm
2.4	20	15	9	7	6	4	2.4	35	5	7	10
								45	4	6	8
3.0	35	25	14	11	9	7	3.0	35	7	10	14
								45	5	8	11
3.6	50	35	20	16	13	10	3.6	35	8	13	18
								45	6	9	13
4.8	70	50	30	29	24	18	4.8	35	10	16	23
								45	7	12	17
6.0	80	60	45	45	37	28	6.0	35	12	20	28
								45	9	15	21

PARKSIDE

F27 Structural & Joinery

Product Catalogue v1.0

APPEARANCE GRADES

NOT PERMITTED

- Loose unsound and defective knots
- Holes > 3 mm;
- Termite galleries
- Loose gum veins and Ring Shakes
- Gum pockets
- Latex and resin pockets
- Overgrowth of injury
- Checks > 1 mm
- Decay
- Included bark
- Primary rot
- Want and Wane
- Hit and Miss,
- Lyctid susceptible sapwood
- Damage by hooks, ropes etc

PACK TAGS

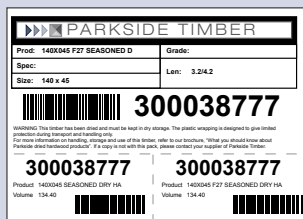

VISUAL STRESS GRADING PARKSIDE STRUCTURAL & JOINERY

SPECIES

SEASONED SPOTTED GUM AND IRONBARK
F27 IN ALL LENGTHS

NATURAL CHARACTERISTICS	GRADE LIMITATIONS
Fractures, Splits and Shakes. Low density, Termite Galleries	NOT ALLOWED
Knots, Branch Stubs, Knot Holes and other Holes (not insect holes)	$\leq 1/4$ W or T (25% W or T)
Borer Holes (no decay) - up to 3 mm dia. - over 3 mm dia. and separated by < 2x dia.	≤ 20 holes per 100 x 100 mm as for knots
Termite Galleries - not enclosed	As for Want & Wane
Slope of Grain	30 in 300 (1 : 10)
Heart - not effecting utilisation	< 20% CAR (cross section)
Heart Shakes - Wavy grain if with sloping grain	not permitted
Tight Gum Veins	unlimited
Loose Gum Veins, Ring Shakes, Included Bark; - aggregate length - intersecting an end surface to surface	≤ 3 mm wide, not surface to surface $\leq 1/6$ L not permitted
Gum Pockets, Latex Pockets, Resin Pockets, Overgrowth of Injury - individual length	≤ 300 mm
Individual width, measure radially - one surface only (lesser of) - one surface to another (lesser of) - one surface to another & intersecting an end	≤ 20 mm ≤ 12 mm as for end splits
End Splits, Aggregate length	$\leq W$ or 100
Checks, other than internal, ≤ 3 mm wide	$\leq 1/3$ L
Internal Checks, Loss of Cross section	$\leq 1/10$
Primary Rot (decay)	≤ 3 mm deep, $\leq 150 \times 100$ mm in any 2 m
Want and Wane - Lyctid Susceptible Sapwood - individual or aggregate	$\leq 1/5$ (20%) cross section $\leq 1/2$ (50%) W or 1/3 (33%) T
Hit and Miss, if more than Want and Wane	≤ 3 mm deep, ind. ≤ 600 mm
Bow, Spring and Twist	See Bow, Spring and Twist Tables;
Cupping	Cupping: 1 mm per 50 mm W



ABOUT

PARKSIDE TIMBER

Product Catalogue v1.0



PARKSIDE TIMBER - Chosen by Families for Generations

PARKSIDE TIMBER has a proud history of producing some of the finest quality hardwood timber products for generations and Parkside's involvement in architectural and designer based projects has been the cornerstone of their business.

PARKSIDE offers a wide variety of species and products to help the greatest of imaginations, and professionals complete their projects.

Parkside has been producing these products for Australians by Australians for over 60 years. The natural durability of the species produced plus the high manufacturing standards held by the Aussies producing PARKSIDE TIMBER products makes their products some of the highest quality in the marketplace.

The Australian market has seen many imported and substitute products come and go, but over the last 60+ years PARKSIDE TIMBER products have been tried and proven, outlasting the competition in both production and application.

Over this time, PARKSIDE have undergone a number of state of the art sawmilling upgrades in green mill practices, kiln drying techniques and the latest improvements in the dry mill, have ensured that PARKSIDE products are second to none in quality.

PARKSIDE dry mill changes including an introduction to state of the art hardwood laser eye sawmilling technology which is the first of its kind seen in the Southern Hemisphere. Due to this upgrade, every PARKSIDE dried product is mechanically analysed and tested to ensure consistency of quality in every piece produced.



AUSTRALIAN FIRST

PARKSIDE are proud of their Australian roots and Australian history. When you look at using PARKSIDE products, you are support an Australian owned and based organisation that provides jobs for Aussies right down the eastern seaboard. PARKSIDE also uses only Australian specie timbers. The most prominent and well known specie PARKSIDE specialise in is Queensland Spotted Gum.

Queensland Spotted Gum is an Australian icon and has been used an array of different applications Australian wide for over 100 years. Spotted Gum has a natural durability of 1 above ground, and PARKSIDE are Australia's leading producer of Spotted Gum, with over 70% of their production focusing on this specie. So when looking at who know and understands Spotted Gum, look no further than PARKSIDE TIMBER.

PARKSIDE PRODUCT BENEFITS

The key benefits to PARKSIDE products are –

- PARKSIDE products are grown in Australia, produced and manufactured in Australia for Australian conditions
- All of PARKSIDE'S products have heartwood timber that is naturally insect and decay resistant while every piece is treated with an ACQ H3 treatment ensuring any sapwood that is used is also fully durable.
- PARKSIDE have some of the highest standards and best quality sawmilling technology in the Southern Hemisphere, meaning their quality is second to none.
- PARKSIDE products are all durability class 1 above ground species; giving you peace of mind your product will hold its integrity for over 40 years!
- PARKSIDE uses some of the highest quality and most unique Australian species, creating some of the most beautiful Australian decks
- PARKSIDE are Australia's largest producer of Spotted Gum products, so you know they know what they are doing especially when milling Spotted Gum.



DATE OF ISSUE: JULY 2017
THIS DOCUMENT SUPERSEDES ALL PREVIOUS VERSIONS



PARKSIDE TIMBER